

BT139B series E

Triacs; sensitive gate

Rev. 03 — 23 September 2004

Product data sheet

1. Product profile

1.1 General description

Passivated, sensitive gate triacs in a SOT404 SMD plastic package.

1.2 Features

- High sensitivity in all four quadrants.

1.3 Applications



- General purpose bidirectional switching
- Phase control.

1.4 Quick reference data

- $V_{DRM} \leq 600$ V (BT139B-600E)
- $V_{DRM} \leq 800$ V (BT139B-800E)
- $I_{T(RMS)} \leq 16$ A
- $I_{TSM} \leq 155$ A
- $I_{GT} \leq 10$ mA (T2+ G+; T2+ G-; T2- G-)
- $I_{GT} \leq 25$ mA (T2- G+).

2. Pinning information

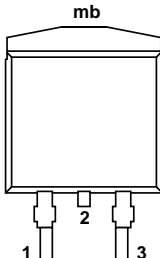
Table 1: Pinning

Pin	Description	Simplified outline	Symbol
1	main terminal 1 (T1)		 <i>sym051</i>
2	main terminal 2 (T2)		
3	gate (G)		
mb	mounting base, connected to main terminal 2 (T2)		

SOT404 (D²-PAK)

PHILIPS

3. Ordering information

Table 2: Ordering information

Type number	Package		Version
	Name	Description	
BT139B-600E	-	plastic single-ended surface mounted package (Philips version of D ² -PAK); 3 leads (one lead cropped)	SOT404
BT139B-800E			

4. Limiting values

Table 3: Limiting values

In accordance with the Absolute Maximum Rating System (IEC 60134).

Symbol	Parameter	Conditions	Min	Max	Unit	
V _{DRM}	repetitive peak off-state voltage		[1]	-	600	V
			BT139B-600E	-	600	V
			BT139B-800E	-	800	V
I _{T(RMS)}	RMS on-state current	full sinewave; T _{mb} ≤ 99 °C; Figure 4 and Figure 5	-	16	A	
I _{TSM}	non-repetitive peak on-state current	full sine wave; T _j = 25 °C prior to surge; Figure 2 and Figure 3	t = 20 ms	-	155	A
			t = 16.7 ms	-	170	A
				-	120	A ² s
I ² t	I ² t for fusing	t = 10 ms	-	120	A ² s	
dI _T /dt	repetitive rate of rise of on-state current after triggering	I _{TM} = 20 A; I _G = 0.2 A; dI _G /dt = 0.2 A/μs	T2+ G+	-	50	A/μs
			T2+ G-	-	50	A/μs
			T2- G-	-	50	A/μs
			T2- G+	-	10	A/μs
				-	5	W
I _{GM}	peak gate current		-	2	A	
V _{GM}	peak gate voltage		-	5	V	
P _{GM}	peak gate power		-	5	W	
P _{G(AV)}	average gate power	over any 20 ms period	-	0.5	W	
T _{stg}	storage temperature		-40	+150	°C	
T _j	junction temperature		-	125	°C	

[1] Although not recommended, off-state voltages up to 800 V may be applied without damage, but the triac may switch to the on-state. The rate of rise of current should not exceed 15 A/μs.

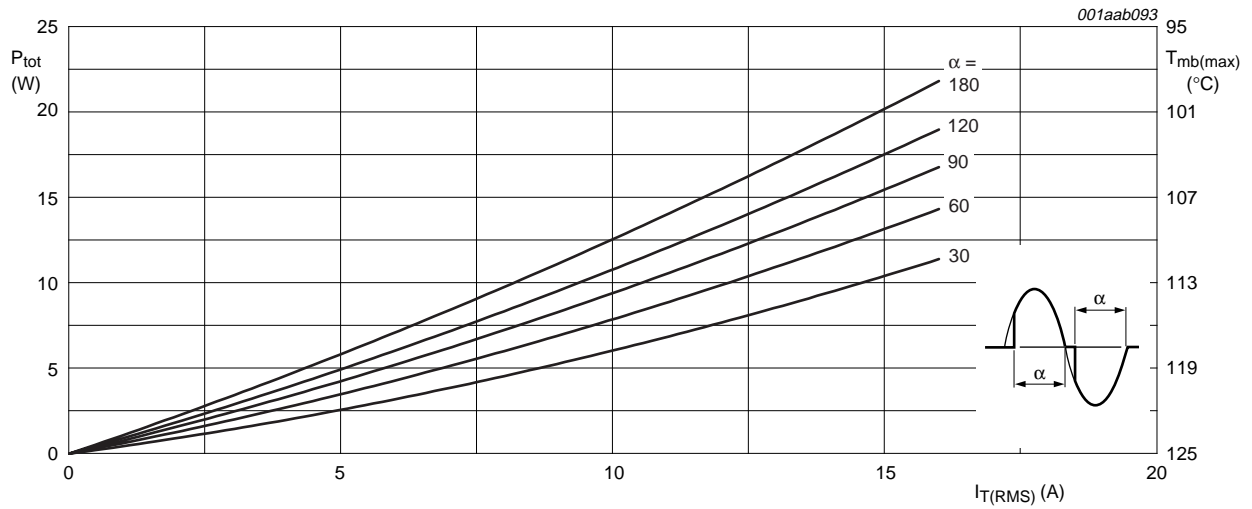

α = conduction angle.

Fig 1. Total power dissipation as a function of RMS on-state current; maximum values.

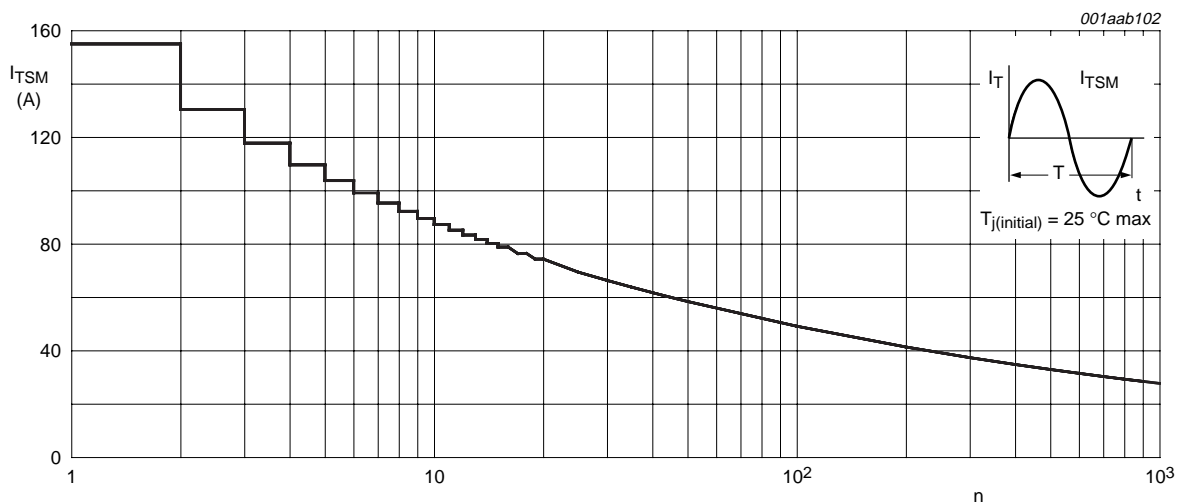

$f = 50$ Hz.

Fig 2. Non-repetitive peak on-state current as a function of the number (n) of sinusoidal current cycles; maximum values.

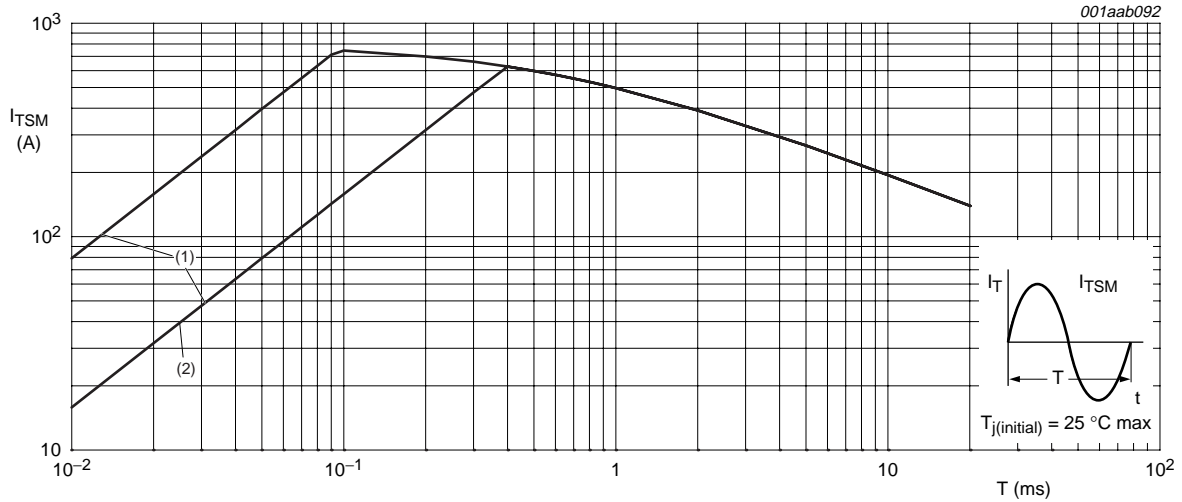

$t_p \leq 20$ ms.

- (1) dI_T/dt limit.
- (2) T2- G+ quadrant.

Fig 3. Non-repetitive peak on-state current as a function of pulse width; maximum values.

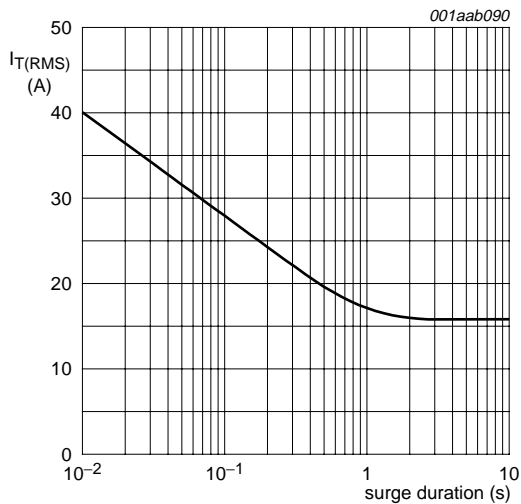

$f = 50$ Hz; $T_{mb} \leq 99$ °C.

Fig 4. RMS on-state current as a function of surge duration; maximum values.

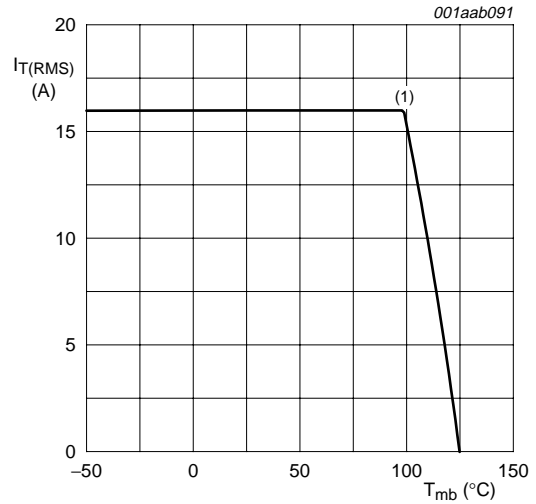

(1) $T_{mb} = 99$ °C.

Fig 5. RMS on-state current as a function of mounting base temperature; maximum values.

5. Thermal characteristics

Table 4: Thermal characteristics

Symbol	Parameter	Conditions	Min	Typ	Max	Unit
$R_{th(j-mb)}$	thermal resistance from junction to mounting base	full cycle; Figure 6	-	-	1.2	K/W
		half cycle; Figure 6	-	-	1.7	K/W
$R_{th(j-a)}$	thermal resistance from junction to ambient	minimum footprint; FR4 printed-circuit board	-	55	-	K/W

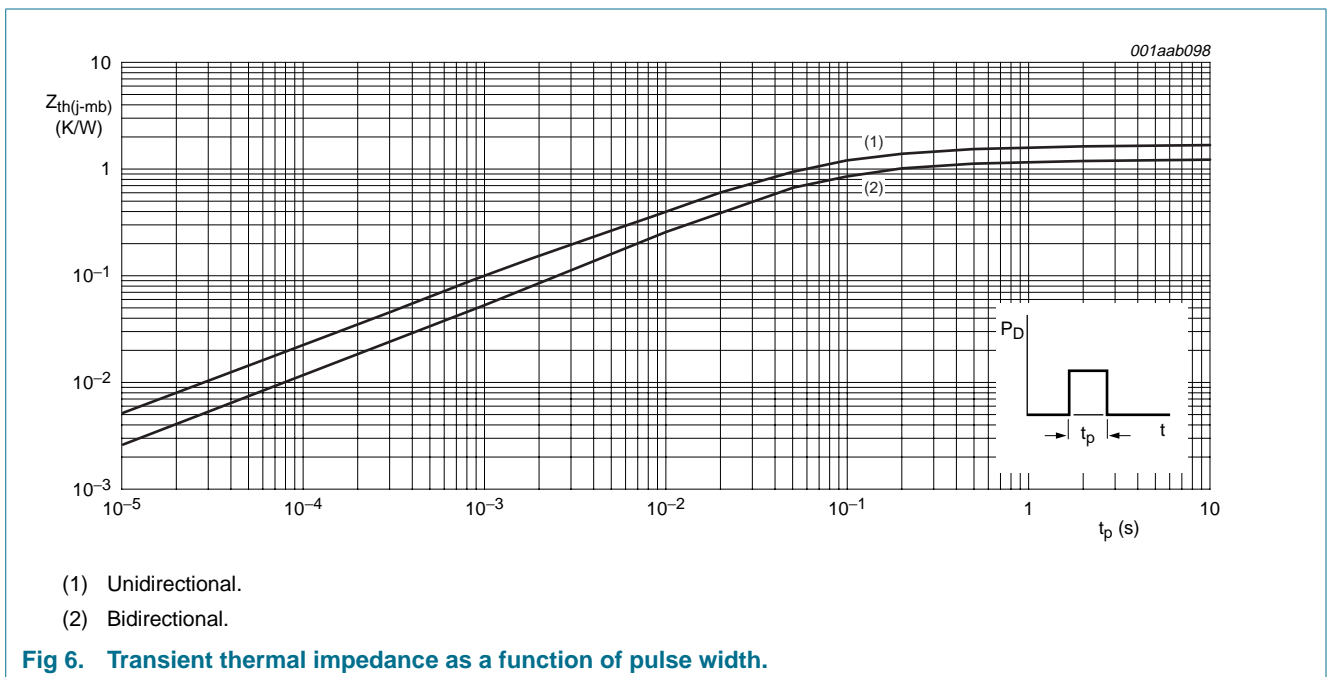

6. Characteristics

Table 5: Characteristics
 $T_j = 25\text{ °C}$ unless otherwise specified.

Symbol	Parameter	Conditions	Min	Typ	Max	Unit
Static characteristics						
I_{GT}	gate trigger current	$V_D = 12\text{ V}$; $I_T = 0.1\text{ A}$; Figure 8				
		T2+ G+	-	2.5	10	mA
		T2+ G-	-	4	10	mA
		T2- G-	-	5	10	mA
		T2- G+	-	11	25	mA
I_L	latching current	$V_D = 12\text{ V}$; $I_{GT} = 0.1\text{ A}$; Figure 10				
		T2+ G+	-	3.2	30	mA
		T2+ G-	-	16	40	mA
		T2- G-	-	4	30	mA
		T2- G+	-	5.5	40	mA
I_H	holding current	$V_D = 12\text{ V}$; $I_{GT} = 0.1\text{ A}$; Figure 11	-	4	45	mA
V_T	on-state voltage	$I_T = 20\text{ A}$; Figure 9	-	1.2	1.6	V
V_{GT}	gate trigger voltage	$V_D = 12\text{ V}$; $I_T = 0.1\text{ A}$; Figure 7	-	0.7	1.5	V
		$V_D = 400\text{ V}$; $I_T = 0.1\text{ A}$; $T_j = 125\text{ °C}$	0.25	0.4	-	V
I_D	off-state leakage current	$V_D = V_{DRM(max)}$; $T_j = 125\text{ °C}$	-	0.1	0.5	mA
Dynamic characteristics						
dV_D/dt	critical rate of rise of off-state voltage	$V_{DM} = 67\% V_{DRM(max)}$; $T_j = 125\text{ °C}$; exponential waveform; gate open circuit	-	50	-	V/ μ s
t_{gt}	gate controlled turn-on time	$I_{TM} = 20\text{ A}$; $V_D = V_{DRM(max)}$; $I_G = 0.1\text{ A}$; $dI_G/dt = 5\text{ A}/\mu$ s	-	2	-	μ s

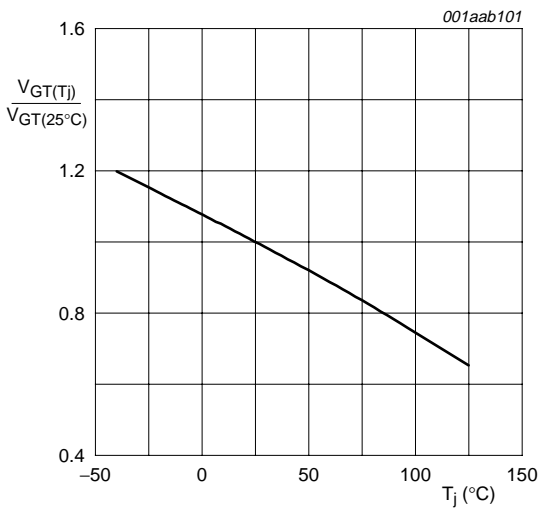
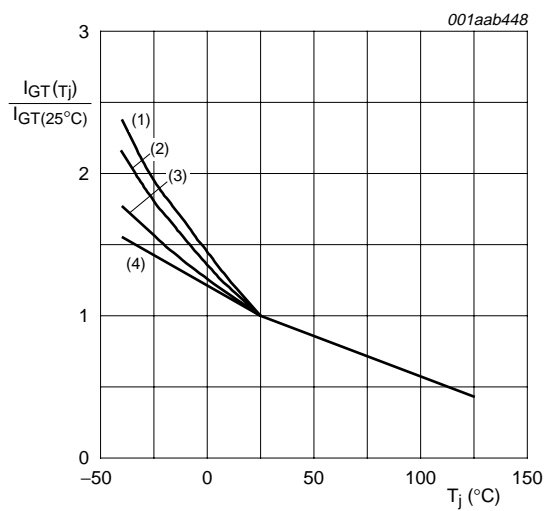
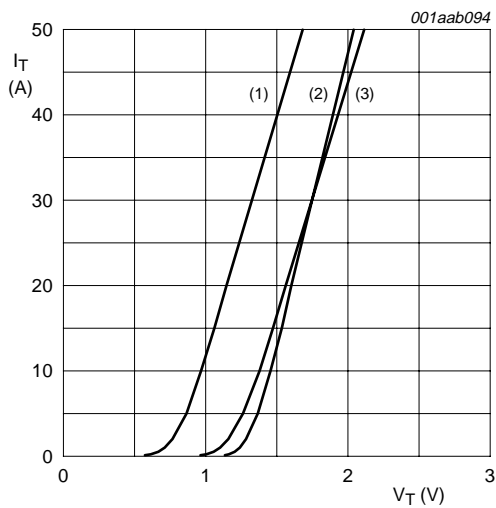

Fig 7. Normalized gate trigger voltage as a function of junction temperature.



- (1) T2- G+.
- (2) T2+ G-.
- (3) T2- G-.
- (4) T2+ G+.

Fig 8. Normalized gate trigger current as a function of junction temperature.



$V_O = 1.195 \text{ V.}$

$R_s = 0.018 \Omega.$

- (1) $T_j = 125 \text{ }^\circ\text{C};$ typical values.
- (2) $T_j = 25 \text{ }^\circ\text{C};$ maximum values.
- (3) $T_j = 125 \text{ }^\circ\text{C};$ maximum values.

Fig 9. On-state current characteristics.

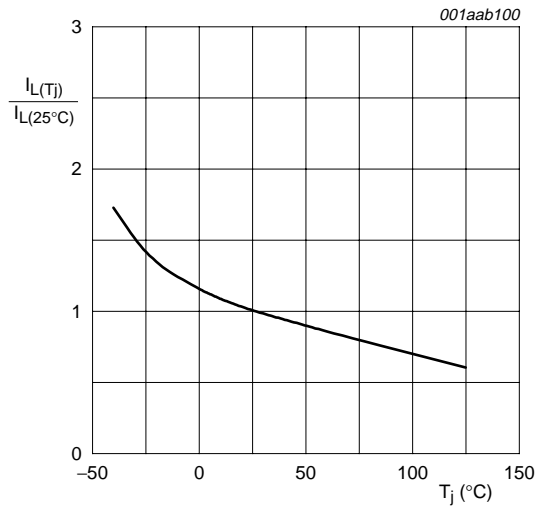

Fig 10. Normalized latching current as a function of junction temperature.

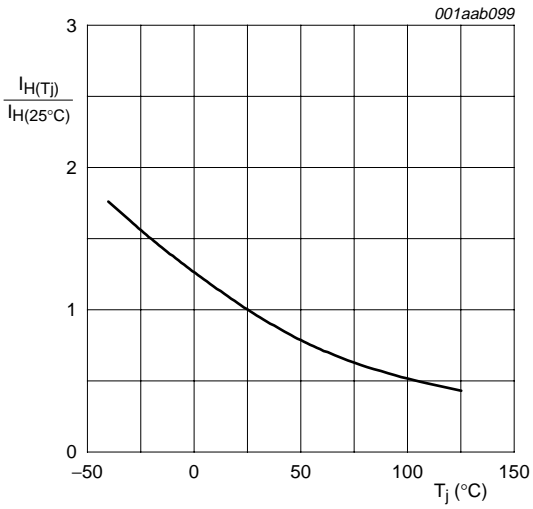

Fig 11. Normalized holding current as a function of junction temperature.

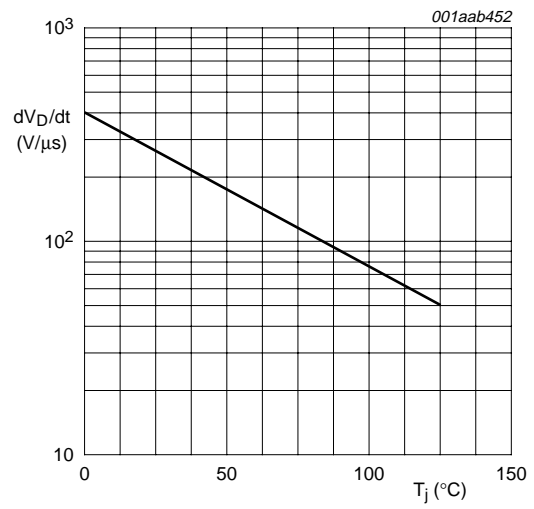
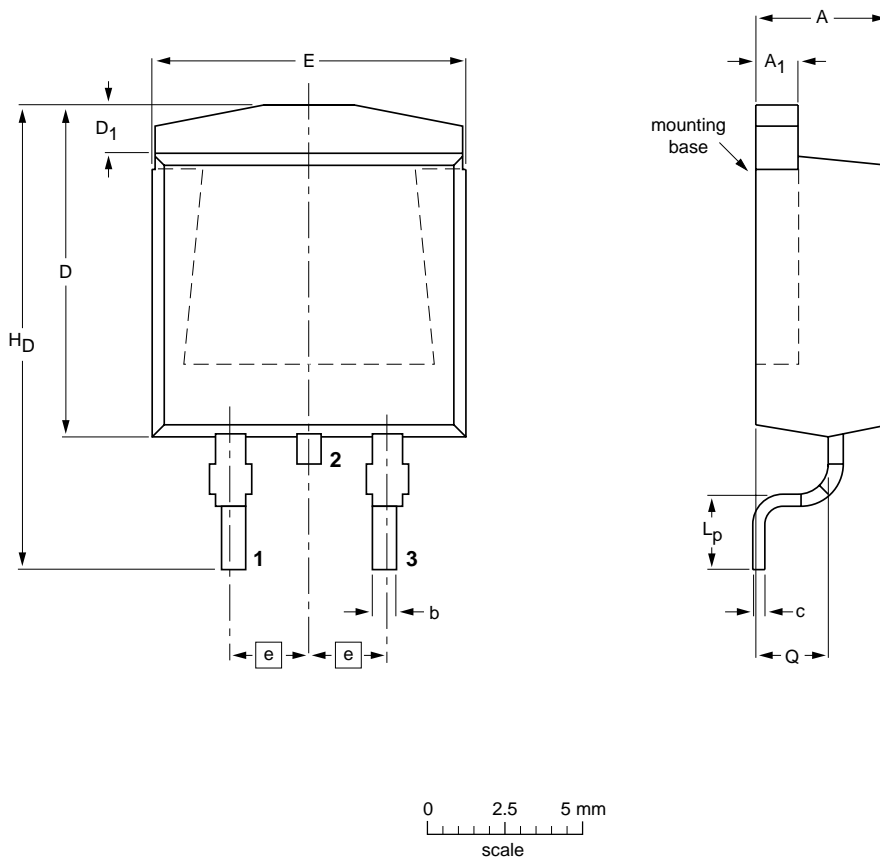

Fig 12. Critical rate of rise of off-state voltage as a function of junction temperature; minimum values.

7. Package outline

Plastic single-ended surface mounted package (Philips version of D²-PAK); 3 leads (one lead cropped)

SOT404



DIMENSIONS (mm are the original dimensions)

UNIT	A	A ₁	b	c	D max.	D ₁	E	e	L _p	H _D	Q
mm	4.50	1.40	0.85	0.64	11	1.60	10.30	2.54	2.90	15.80	2.60
	4.10	1.27	0.60	0.46		1.20	9.70		2.10	14.80	2.20

OUTLINE VERSION	REFERENCES				EUROPEAN PROJECTION	ISSUE DATE
	IEC	JEDEC	EIAJ			
SOT404						99-06-25 01-02-12

Fig 13. Package outline; SOT404 (D²-PAK).

8. Revision history

Table 6: Revision history

Document ID	Release date	Data sheet status	Change notice	Doc. number	Supersedes
BT139B_SERIES_E_3	20040923	Product data sheet	-	9397 750 13438	BT139B_SERIES_E_2
Modifications:	<ul style="list-style-type: none">The format of this data sheet has been redesigned to comply with the new presentation and information standard of Philips Semiconductors.				
BT139B_SERIES_E_2	20010701	Product specification	-	-	BT139B_SERIES_E_1
BT139B_SERIES_E_1	19970301	Product specification	-	-	-

9. Data sheet status

Level	Data sheet status ^[1]	Product status ^[2] ^[3]	Definition
I	Objective data	Development	This data sheet contains data from the objective specification for product development. Philips Semiconductors reserves the right to change the specification in any manner without notice.
II	Preliminary data	Qualification	This data sheet contains data from the preliminary specification. Supplementary data will be published at a later date. Philips Semiconductors reserves the right to change the specification without notice, in order to improve the design and supply the best possible product.
III	Product data	Production	This data sheet contains data from the product specification. Philips Semiconductors reserves the right to make changes at any time in order to improve the design, manufacturing and supply. Relevant changes will be communicated via a Customer Product/Process Change Notification (CPCN).

[1] Please consult the most recently issued data sheet before initiating or completing a design.

[2] The product status of the device(s) described in this data sheet may have changed since this data sheet was published. The latest information is available on the Internet at URL <http://www.semiconductors.philips.com>.

[3] For data sheets describing multiple type numbers, the highest-level product status determines the data sheet status.

10. Definitions

Short-form specification — The data in a short-form specification is extracted from a full data sheet with the same type number and title. For detailed information see the relevant data sheet or data handbook.

Limiting values definition — Limiting values given are in accordance with the Absolute Maximum Rating System (IEC 60134). Stress above one or more of the limiting values may cause permanent damage to the device. These are stress ratings only and operation of the device at these or at any other conditions above those given in the Characteristics sections of the specification is not implied. Exposure to limiting values for extended periods may affect device reliability.

Application information — Applications that are described herein for any of these products are for illustrative purposes only. Philips Semiconductors make no representation or warranty that such applications will be suitable for the specified use without further testing or modification.

11. Disclaimers

Life support — These products are not designed for use in life support appliances, devices, or systems where malfunction of these products can reasonably be expected to result in personal injury. Philips Semiconductors customers using or selling these products for use in such applications do so at their own risk and agree to fully indemnify Philips Semiconductors for any damages resulting from such application.

Right to make changes — Philips Semiconductors reserves the right to make changes in the products - including circuits, standard cells, and/or software - described or contained herein in order to improve design and/or performance. When the product is in full production (status 'Production'), relevant changes will be communicated via a Customer Product/Process Change Notification (CPCN). Philips Semiconductors assumes no responsibility or liability for the use of any of these products, conveys no license or title under any patent, copyright, or mask work right to these products, and makes no representations or warranties that these products are free from patent, copyright, or mask work right infringement, unless otherwise specified.

12. Contact information

For additional information, please visit: <http://www.semiconductors.philips.com>

For sales office addresses, send an email to: sales.addresses@www.semiconductors.philips.com

13. Contents

1	Product profile	1
1.1	General description	1
1.2	Features	1
1.3	Applications	1
1.4	Quick reference data	1
2	Pinning information	1
3	Ordering information	2
4	Limiting values	2
5	Thermal characteristics	5
6	Characteristics	6
7	Package outline	9
8	Revision history	10
9	Data sheet status	11
10	Definitions	11
11	Disclaimers	11
12	Contact information	11



© Koninklijke Philips Electronics N.V. 2004

All rights are reserved. Reproduction in whole or in part is prohibited without the prior written consent of the copyright owner. The information presented in this document does not form part of any quotation or contract, is believed to be accurate and reliable and may be changed without notice. No liability will be accepted by the publisher for any consequence of its use. Publication thereof does not convey nor imply any license under patent- or other industrial or intellectual property rights.

Date of release: 23 September 2004
Document number: 9397 750 13438

Published in The Netherlands